

# Beverage Antennas for Amateur Communications

Contrary to popular belief, the Beverage antenna can be used as an effective receiving *and* transmitting antenna for frequencies: up to 30 MHz.

By John S. Belrose,\* VE2CV, John Litva,\* G. E. Moss\* and E. E. Stevens,\*\*VE3CYO

A Beverage antenna is a broad-band aperiodic antenna that can be used over a frequency range of 2 to 30 MHz. It consists of a long wire stretched horizontally over the ground. In essence, it is a lossy transmission line with the ground acting as an imperfect conductor (Fig. 1). The antenna is terminated in the characteristic impedance of 400 to 600 ohms through a ground screen, with the received signal taken from the other end through a matching transformer that has one side connected to ground. This transformer is used to match the feed impedance of the antenna to 50-ohm coaxial cable. Dimensions of a typical Beverage antenna would be about 360 feet long and 6 feet above the ground.

Beverage antennas can be used for receiving (single element) or transmitting (multiple-element array) applications. While no detailed study has been made on the optimum size of ground screens, the hf Beverage antennas we built employed radial ground screens comprised of 16 radials, 50 feet long, staked at the ends by 2-foot-long rods. Multielement arrays employ smaller ground systems — in our case, six radials, each 20 feet long. The connections to the ground-side of the matching transformer and the terminating resistors were made with three, 3/4-inch-wide copper mesh ground straps.

## Previous Work

The initial Beverage antenna work was carried out by H. H. Beverage and associates, who tested the antennas on a transoceanic circuit using very long waves of 12 to 42 kHz, and at medium frequencies of 250 to 1500 kHz.<sup>2,3,4</sup> They found antenna lengths of approximately 1 wavelength were effective in reducing in-

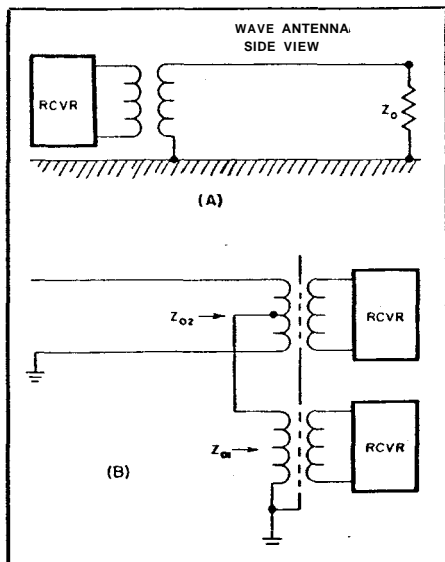

Fig. 1 — Alternative forms of wave antennas: (A) simplest form for unidirectional reception; (B) two-wire wave antenna for separate reception from reciprocal directions.

terference and static because of the directive nature of the antenna and its low response to radio noise. Wait and Mousseau calculated vertical-plane field patterns for horizontal traveling-wave antennas.<sup>7</sup> Travers and associates did extensive theoretical and experimental research with hf Beverage antennas from 1961 to 1967.<sup>6</sup> Their work is documented in a series of reports that have had limited distribution. A brief account of their work appears in a paper by Martin.<sup>7</sup> More recently, Litva and Rook gave a detailed description of experimental and theoretical results obtained from an extensive study of hf Beverage antennas.\* Their theoretical work, supported by extensive experimental measurements, provides comprehensive Beverage antenna engineering data in a readily accessible format for the communications engineer.

Beverage antennas are shown to be effective as “building blocks” for large hf arrays: When multiple Beverage elements are employed, the antenna system has sufficient gain at hf to be efficient in both receiving and transmitting. Of course, the directivity and size of such an array would dictate bidirectional point-to-point operation.

Two-wire wave antennas for reception in reciprocal directions have been described by Laport and Misek (Fig. 1B).<sup>9,10</sup> This bidirectional wave antenna is unusual in that it simultaneously possesses two directivity patterns. The wave field impinges simultaneously upon the two wires, and equal currents flow in both wires in the direction of wave travel. These currents continue to flow until they reach the far end of the antenna, where reflection occurs by grounding one wire and leaving the other open-circuited. This balances the current received from the right, but has no effect on the unbalanced current received from the left. To obtain sufficient balances in the transformers, an electrostatic shield is required. The two receivers for simultaneous reception in the two reciprocal directions are matched to  $Z_{01}$  and  $Z_{02}$ .  $Z_{01}$  designates the characteristic impedance of two wires unbalanced to ground, and  $Z_{02}$  is the balanced characteristic impedance between the wires. Basically, the bidirectional wave antenna is an aperiodic antenna whose terminations have been transposed to the receiving end. This provides greater flexibility in controlling the antenna with simple switching and phasing circuits.

## Comparison Between Theory and Experiment

Detailed measurements were made for Beverage antennas of various lengths and heights, with a typical length of 360 feet. Also, various grounds were tested. The received signal strengths were measured at

\*Notes appear on page 27

\*Communications Research Center, Department of Communications, P.O. Box 11490, Station H, Ottawa, ON K2H 8S2

\*\*513-1485 Baseline Rd., Ottawa, ON

several frequencies, and airborne transmitters were used for signal generation. An aircraft towed a vertically polarized transmitting dipole, called XELEDOP (Transmitting Elementary Dipole of arbitrary Polarization)."

To develop azimuthal patterns with XELEDOP, the antenna must be towed concentrically around the antenna under test (AUT) at various heights and distances. A cut of the vertical pattern can be obtained by flying across the AUT at a given height (1.9 miles, typically) along the boresite, correcting the results for spatial attenuation, and for the changing angle between the XELEDOP dipole and the AUT ray direction.

Several antenna pattern measurements were made using a dipole suspended from a balloon. These measurements were made on a radius of about 1600 feet from the AUT, with the dipole coming within a quarter wavelength of the ground. Some examples of the various results using both balloon and XELEDOP techniques are shown in Figs. 2, 3 and 4.

In Fig. 2, a comparison is drawn between theoretical and experimental azimuthal patterns measured by the XELEDOP technique at 18 MHz. The vertical pattern (corresponding to the azimuthal pattern in Fig. 2C) is shown in Fig. 3. Measurements were also done using a 1/4-wave ground-plane antenna as a reference to measure the gain of the Beverage ground wave.

The results of detailed measurements of the vertical pattern at the azimuth of maximum gain are illustrated in Fig. 4. These results deserve some discussion. In this test, the AUT was a Beverage pair (two elements of a rosette array); therefore, the theoretical gain should increase 3 dB over a single Beverage element. The balloon measurements for low elevation angles ( $\psi < 3^\circ$ ) clearly illustrate the response of the antenna to ground waves. The skywave lobe was a maximum at  $\psi_N \sim 16^\circ$ .

Clearly, there is a consistent agreement between theory and experiment in the main lobe, but a fairly large discrepancy in the side- and back-lobe levels. Typically, the side lobes of theoretical patterns are 25 dB lower than the main beam, whereas measured values are normally only about 15 dB below the level of the main beam.

#### Theoretically Derived Parameters for Beverage Antennas

Since the agreement between experiment and theory was, except in some instances, reasonably good, it follows that theoretically derived parameters can be used with confidence in Beverage antenna design. Since theory reveals design trends better than experimentation, we shall consider the effects of length, height, frequency and ground conductivity on the Beverage antenna.

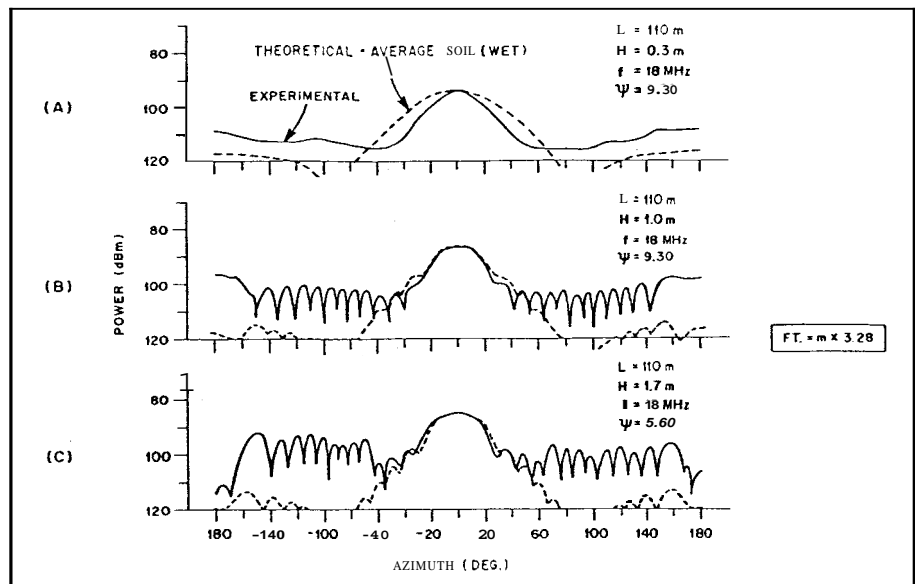

Fig. 2 — Comparison of theoretical and experimental azimuthal patterns for a Beverage antenna at 18 MHz.

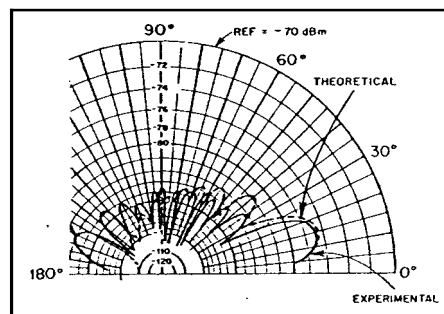

Fig. 3 — Comparison of theoretical and experimental vertical pattern in the bore-site direction (at 18 MHz) for an antenna length of 360 feet and a height of 4 feet (azimuthal pattern is shown in Fig. 2C).

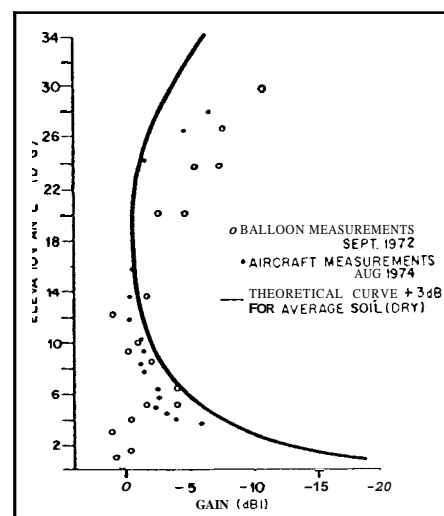

Fig. 4 — Vertical radiation pattern for a Beverage-pair antenna in azimuth of the main lobe at 9.5 MHz.

The length of a Beverage antenna should be greater than 1 wavelength, and since we are concerned with frequencies of 1.8 to 30 MHz, an antenna 656 feet long should give satisfactory performance at 1.8 MHz. Figs. 5, 6 and 7 are examples of design parameters — calculated values of gain in the main lobe ( $G_N$ ), azimuthal beamwidth ( $BW_A$ ), launch angle ( $\psi_N$ ) and vertical beamwidth ( $BW_\psi$ ) for Beverage antennas 328, 656 and 984 feet long, all 6.5 feet high over average dry soil.

Figs. 8, 9 and 10 illustrate how the gain ( $G_N$ ) varies with antenna length, antenna height and soil conductivity. Fig. 8 illustrates that the optimum length for a Beverage antenna mounted 6.5 feet above average dry soil is about 4 lambda. In Fig. 9, it is shown that the gain increases at all frequencies as the height increases from 12 inches to 10 feet. The change is especially marked at the higher frequencies. The curves in Fig. 10 show the dependence of gain on earth conductivity. At 2 MHz, the gain decreases as earth conductivity increases, whereas at higher frequencies this variation has the opposite trend: Gain increases as conductivity increases.

#### Beverage Antenna Arrays for Transmitting Applications

While Beverage antennas are good for receiving because of their directivity and low noise, their efficiency is rather low. Compare, for example, the gain figures for the Beverage antennas discussed above with that of a quarter-wave antenna over a perfectly conducting earth, which is 5.16 dBi. For hf-receive applications, discrimination or directivity gain is the important factor, as the system signal-to-noise ratio is determined by ambient radio

noise, not the internal-equipment noise as at vhf. Thus, a directive receiving antenna can be many decibels below isotropic reference and still be useful. Consequently, the lack of efficiency in the Beverage antenna is of no importance for receiving. During transmission, however, poor efficiency represents power wasted, since radiation efficiency is a measure of the power radiated divided by the power of the transmitter.

Beverage antennas can be operated as linear phased arrays, employing several closely spaced Beverage-antenna elements fed in phase. The power gain of such an array increases by about 3 dB each time the number of elements is doubled, provided the elements are independent. The effect of interaction among elements, which limits the efficiency achievable by such arrays, has been determined. For element heights on the order of 6.5 feet, the

interelement spacing can be as small as 20 feet. If there is sufficient land to mount a Beverage antenna in its length, only a modest increase in complexity could provide a power-gain increase of 3 or 6 dB by

employing 2 or 4 elements in a linear phased array.

An example of a Beverage array is shown in Fig. 11. It consisted of eight 500-foot elements mounted 6 feet above

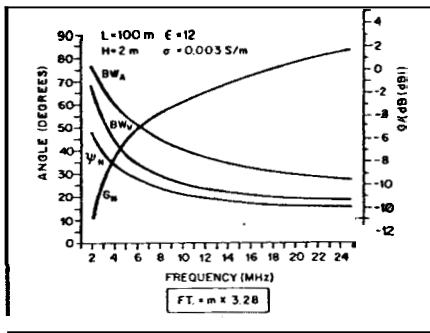

Fig. 5 — Design parameters for average dry soil:  $H = 6.5$  ft;  $L = 328$  ft.

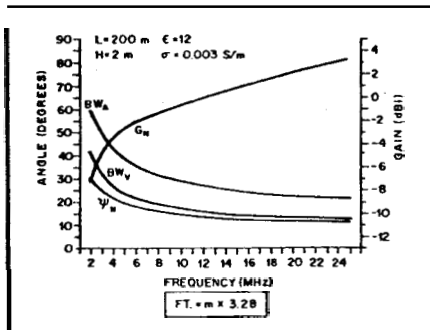

Fig. 6 — Design parameters for average dry soil:  $H = 6.5$  ft;  $L = 656$  ft.

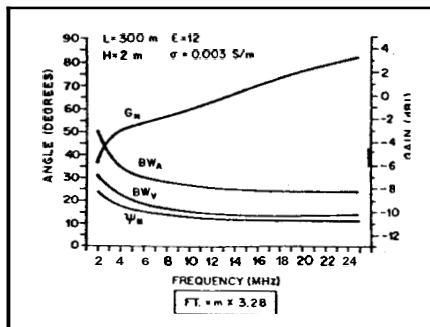

Fig. 7 — Design Parameters for average dry soil:  $H = 6.5$  ft;  $L = 984$  ft.

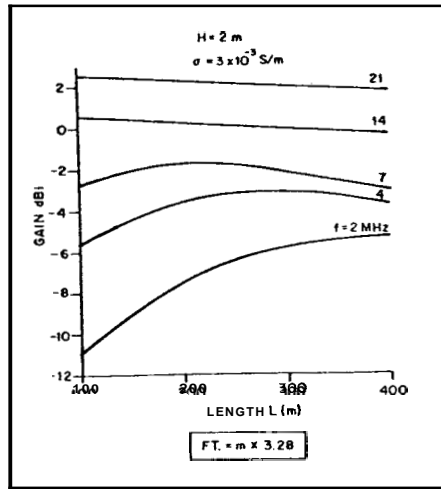

Fig. 8 — Gain of a Beverage antenna element as a function of frequency and length ( $H = 6.5$  ft, average dry soil).

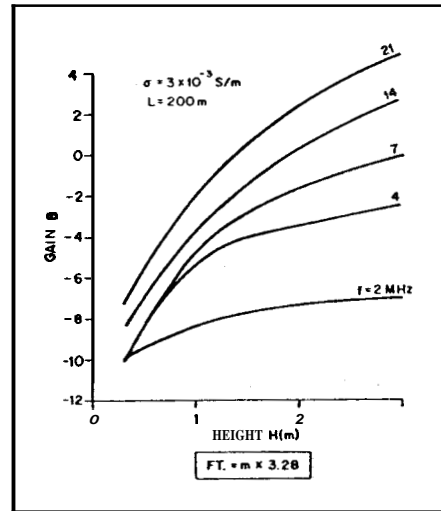

Fig. 9 — Gain of a Beverage antenna element as a function of frequency and height ( $L = 656$  ft, average dry soil).

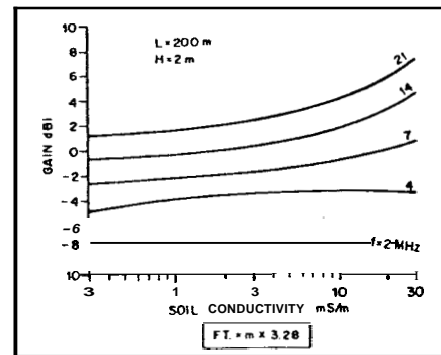

Fig. 10 — Gain of a Beverage antenna element as a function of frequency and conductivity ( $L = 656$  ft;  $H = 6.5$  ft).

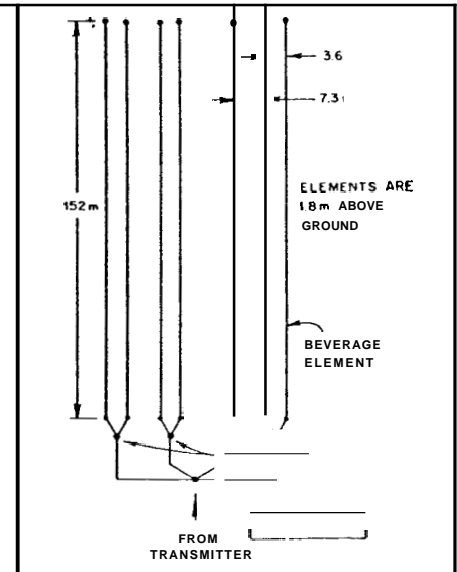

Fig. 11 — Plane view of an experimental Beverage array. See text for details.

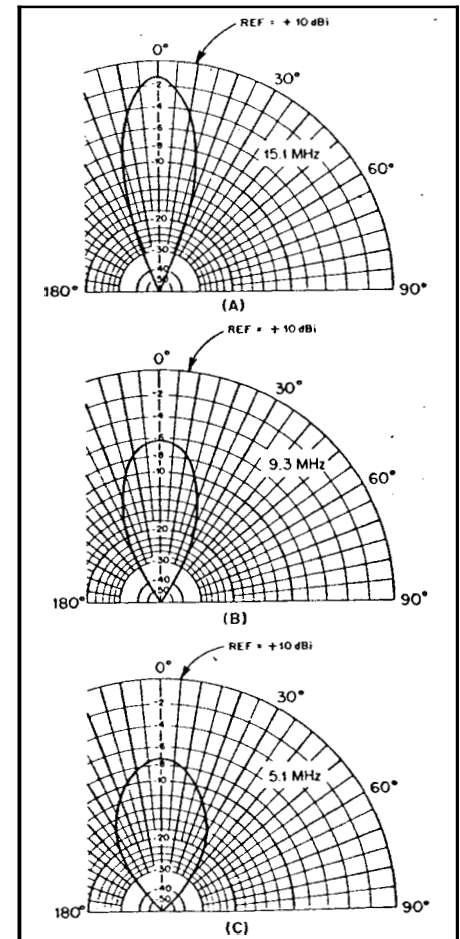

Fig. 12 — Measured azimuthal patterns for the experimental Beverage array shown in Fig. 11. Note that the 0 dB reference corresponds to +10 dBi.

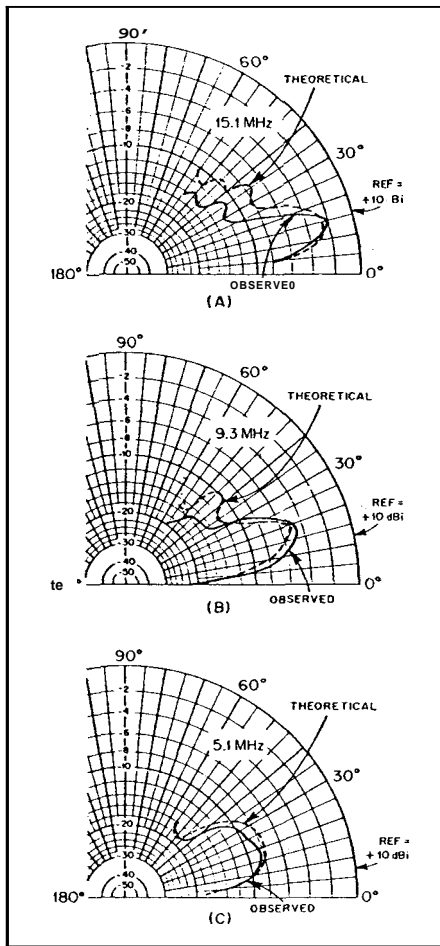

Fig. 13 — Measured and theoretical elevation patterns for the experimental Beverage array shown in Fig. 11. Note that the 0 dB reference corresponds to +10 dBi.

the ground, with the elements arranged in pairs. Each pair was coupled directly to a matching transformer, which was connected through a length of coaxial cable to a 1:4 power divider. The measured azimuthal and elevation patterns, expressed in dBi, are shown in Figs. 12 and 13, with those for 5.1, 9.3 and 15.1 MHz shown in A, B and C. The theoretical plot in Fig. 13 demonstrates the close agreement between practical results and theoretical calculations of the main lobe. The pattern results were repeated for summer (3-foot-high grass, damp ground) and winter (6-inch dense snow cover, partially frozen ground) with no change in the results.

### Conclusions

The Beverage antenna and arrays of Beverage elements present an inexpensive alternative for transmitting and receiving on long-range, point-to-point communications circuits. The disadvantage, from a radio amateur's viewpoint, is that gain is realized in only one or two reciprocal directions and a large amount of real estate is required for a Beverage array on the lower hf bands.

### Appendix

The Beverage antenna is analyzed as a transmission line in which current has been induced by the impinging electromagnetic field parallel to the Beverage wire. The characteristic impedance and propagation parameters derived (or measured) from transmission-line theory are therefore important elements in analyzing the performance of the antenna. The simplest formula for the characteristic impedance of a single wire over a ground is

$$Z_o = 60 \ln \frac{2h}{a} \quad (\text{Eq. 1})$$

where

- h = height of the Beverage wire above ground
- a = radius of wire
- n = antenna current-wave propagation factor

Although a more complicated analysis of the impedance of a wire over lossy ground is discussed by Litva and Rook, the detailed analysis does not improve the agreement with the experimental data. The impedance and propagation characteristics of the transmission line can be determined experimentally by measuring the input impedance of the line with the far end open and short circuited; or, by measuring the current on the antenna by means of a small probe that is excited by an rf generator. The characteristic impedance is calculated from the open and closed circuit impedance measurement:

$$Z_o = \sqrt{Z_{oc} \times Z_{sc}} \quad (\text{Eq. 2})$$

where  $Z_{oc}$  = open-circuit line impedance at a given frequency ( $F_G$ )

$Z_{sc}$  = short-circuit line impedance at  $F_G$ .

The input impedance is generally complex. The propagation constant  $\gamma = \alpha + j\beta$  is another important parameter:

$$\gamma = \frac{1}{l} \tanh^{-1} \sqrt{\frac{Z_{sc}}{Z_{oc}}} \quad (\text{Eq. 3})$$

The real and imaginary parts of this parameter are the attenuation ( $\alpha$  in nepers/meter) and the phase constant ( $\beta$  in radians/meter), which are needed to calculate the current wave that traverses the wire.

The velocity of propagation can be obtained from the current measurements, or from the open (or short) circuit impedance measurements, since the input is high (or low) when the electrical length of the line is an integral multiple of a half (or quarter) wavelength.

In Fig. 14, the average characteristic impedances of a 360-foot antenna about 4 feet (mean height) over average wet soil (for soil conductivities and types see Table 1) is shown

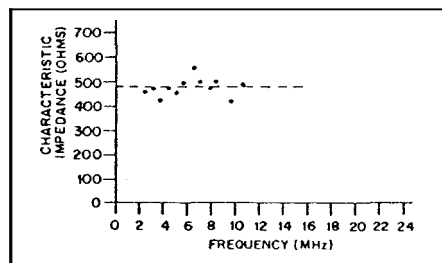

Fig. 14 — Characteristic impedance of a Beverage antenna 360 feet long and 3.7 feet high situated over average wet soil.

Table 1

Soil Conductivities and Types	Conductivity S/m	Dielectric Constant
Sea Water	5	81
Average soil (wet)	$10 \times 10^{-3}$	10-15
Average soil (dry)	$3 \times 10^{-3}$	10-15
Poor soil	$1 \times 10^{-3}$	10
Poor soil (dry)	$3 \times 10^{-4}$	8
Dry sand	$1 \times 10^{-4}$	5

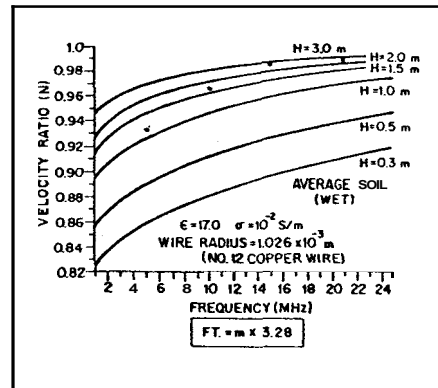

Fig. 15 — Theoretical and experimental values of current-wave velocity factor as a function of frequency for average wet soil (the experimental values were for an antenna height of 3.7 feet).

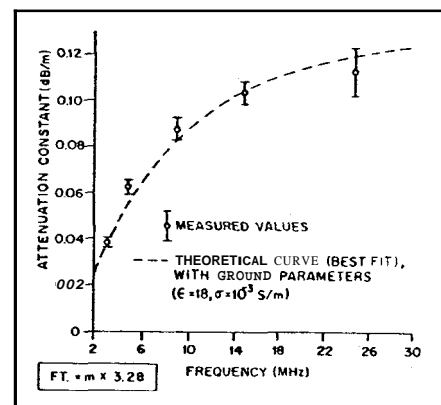

Fig. 16 — Attenuation as a function of frequency for a 6-foot-high Beverage antenna over poor soil.

for the range of 2 to 24 MHz. The mean value is 480 ohms, but clearly a single value for a terminating resistor will not result in absence of reflection from the end of the antenna. It should be noted that  $Z_o$  (calculated) equals 462 ohms. The Beverage wire was no. 12 copper-clad steel, for which  $a = 0.0043$  in. Using Eq. 1:

$$Z_o = 60 \ln \frac{2(4.13)(100)}{0.0043} = 462 \text{ ohms} \quad (\text{Eq. 4})$$

In Fig. 15, we compare measured and calculated values for the current-wave velocity factor. The theoretical values have been calculated for various heights above average wet ground. The measured values were determined from current measurements. In Fig. 16; we show a comparison between theoretical and measured current-wave attenuation

(decibels/meter) of another Beverage antenna which appears to have a poor soil ground.

### Theory of Operation

A Beverage antenna responds to vertically polarized waves in that it responds to the horizontal component of the vertically polarized ground wave, owing to the tilt of the wavefront, and to the sky wave, because of the tilt of the downcoming wave front. A vertically polarized ground wave at the surface of the earth will have a forward tilt, the magnitude of which depends on the conductivity and permittivity of the earth. This slight tilt forward, in the direction of propagation, is responsible for a small vertical downward component, sufficient to furnish the power dissipated in the earth over which the wave is passing, and it is the horizontal component parallel to the Beverage wire antenna that induces a current on it (Fig. 17A). This current flows in the direction of the wave travel, which is toward the receiver. All portions of the antenna collect energy from the impinging wave field in space, so long as the phase of the wave in the antenna does not differ greatly from the exciting field. The gain of a Beverage antenna, relative to an isotropic radiator, for surface or ground waves has been derived by Litva and Rook:

$$G = \frac{377\pi \sin^2 \delta}{Z_0 \lambda^2} \left| \frac{1 - \epsilon_r \Gamma^2}{\Gamma} \right|^2 \quad (\text{Eq. 5})$$

$\delta$  = tilt angle of surface wave

$$\delta = \tan^{-1} \left[ \frac{(\epsilon_g - 1)^2 + \left(\frac{\sigma_g}{\epsilon_0 \omega}\right)^2}{\left[\epsilon_g^2 + \left(\frac{\sigma_g}{\epsilon_0 \omega}\right)^2\right]^{1/2}} \right]^{1/4} \quad (\text{Eq. 6})$$

$$= 1.44 + 12653 \times 10^{-8}$$

$$= 1.63 \times 10^{-8}$$

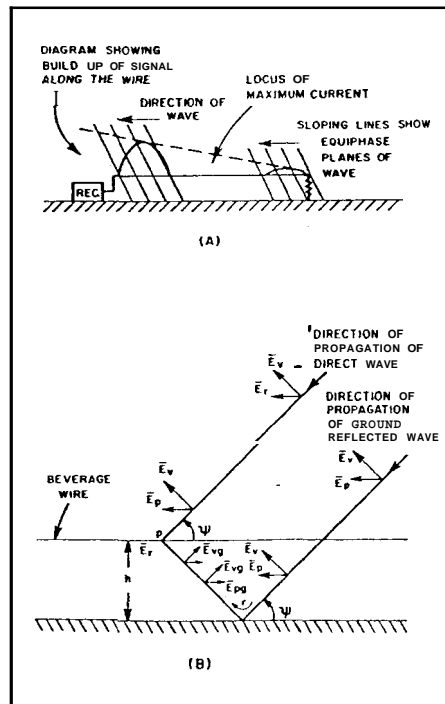

Fig. 17 — The wave or Beverage antenna illustrating: (A) current buildup along the wire for reception of ground wave; and (B) parallel voltage element induced in Beverage wire because of a vertically polarized downcoming sky wave.

where

- $\omega = 2\pi f$
- $\epsilon_0$  = permittivity of free space
- $\epsilon_g$  = relative dielectric constant of the earth
- $\sigma_g$  = conductivity of the earth
- $\Gamma = \gamma - j\beta_0 \cos \delta$
- $\gamma = \alpha + j\beta$
- $\beta_0 = 2\pi/\lambda$
- $\lambda$  = free space wavelength
- $l$  = length of antenna
- $\alpha$  = current-wave attenuation on antenna (nepers/meter)
- $\beta = \beta_0/n$

For skywaves, wave tilt is provided by the arrival angle of the downcoming plane wave (see Fig. 17B), and the magnitude of the induced voltage will depend on the parallel component of the vertically polarized electric field. Again, this induced voltage will cause a current wave to traverse the wire, in the direction of propagation, toward the receiver. The report by Litva and Rook derives expressions for the skywave gain of the Beverage antenna and a computer listing program to calculate the necessary design parameters. Here, we consider the analysis in outline only. The magnitude of the induced voltage on the wire is calculated from the resultant field parallel to the Beverage wire  $\bar{E}_r$ , where

$$\bar{E}_r = \bar{E}_v \sin \psi (1 - \rho_v e^{-j\frac{2\pi}{\lambda} 2h \sin \psi}) \quad (\text{Eq. 7})$$

where  $\rho_v$  is the reflection coefficient for vertically polarized ground waves:

$$\rho_v = \rho e^{j\theta} = \frac{\sqrt{\epsilon_c} \sin \psi - \sqrt{\epsilon_c^2 - \cos^2 \psi}}{\sqrt{\epsilon_c} \sin \psi + \sqrt{\epsilon_c^2 - \cos^2 \psi}} \quad (\text{Eq. 8})$$

where  $\epsilon_c$  is complex and is given by:

$$\epsilon_c = \epsilon_r - j \frac{\sigma_g}{\omega \epsilon_0} \quad (\text{Eq. 9})$$

where

- $\epsilon_r$  is the ratio of the dielectric constant of the ground to that of free space
- $\sigma_g$  is the ground conductivity in mho/meter
- $\epsilon_0$  is the permittivity of free space ( $8.85 \times 10^{-12}$  farads/meter)

The negative sign in the equation for  $\bar{E}_r$  indicates that the horizontal components of the direct and ground-reflected wave are oppositely directed in space.

Since  $\bar{E}_r$  is parallel to the Beverage wire, a potential gradient results, and the voltage induced in the line can be calculated. This elemental voltage gives rise to an elemental current, and the total current, as a function of the elevation angle  $\psi$  and azimuth angle  $\theta$ , is obtained by integrating over the length of the line. The resulting expression is a complicated function dependent on the transmission-line characteristics, the properties of the ground, the height of the antenna above the ground, and the length of the Beverage wire.

The derived expressions follow. The power gain of a Beverage antenna referred to that of an isotropic radiator is

$$P_G = \frac{4\pi \mu_0 c}{\lambda^2} |I_T(\psi, \theta)|^2 \text{Re}(Z_0) \quad (\text{Eq. 10})$$

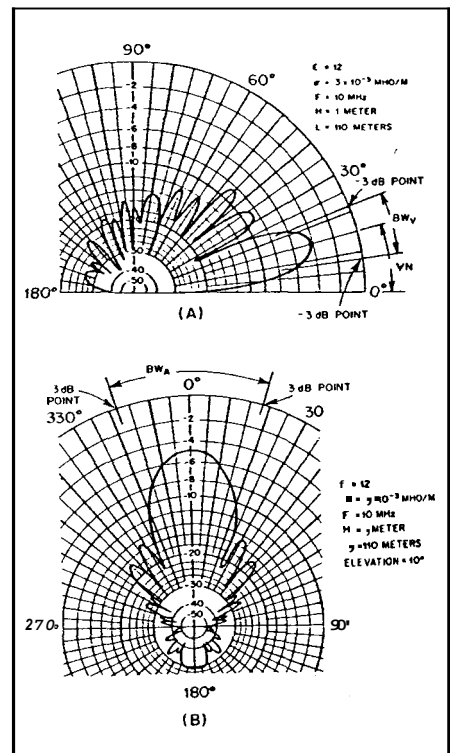

Fig. 18 — Theoretical elevation and azimuthal patterns for a Beverage antenna element situated over average dry soil. The length is 360 feet and height is 3 feet.

(assuming  $E_v = \text{unity}$ )

where

- $\mu_0$  = permeability of free space ( $4 \times 10^{-7}$ )
- $c$  = velocity of light
- $\text{Re}(Z_0)$  = real part of complex characteristic impedance of Beverage wire
- $I_T(\psi, \theta)$  = resultant current at receiving end of antenna, which is

$$I_T(\psi, \theta) = \frac{E_r}{2Z_0} e^{-\frac{\gamma l}{2}} \cos \theta \times \left[ \frac{\sinh \left[ \frac{\gamma_1 l}{2} \right]}{\gamma_1 l} + \text{PL} e^{\gamma l} \frac{\sinh \left[ \frac{\gamma_2 l}{2} \right]}{\gamma_2 l} \right] \quad (\text{Eq. 11})$$

where PL is the reflection coefficient, since in general  $Z_L$  will not equal  $Z_0$  at all frequencies:

$$\text{PL} = \frac{Z_L - Z_0}{Z_L + Z_0} \quad (\text{Eq. 12})$$

- $Z_L$  = terminating resistance
- $\gamma_1 = \alpha + j\beta (1 - N \cos \psi \cos \theta)$
- $\gamma_2 = \alpha + j\beta (1 + N \cos \psi \cos \theta)$

$$N = \frac{\mu}{c}$$

where

- $\mu$  = velocity of propagation of current on the wire
- $c$  = velocity of light

A typical theoretical elevation and azimuthal pattern for a Beverage antenna over average dry soil is shown in Fig. 18.

Notes

<sup>1</sup>m = ft x 0.3048; mi = km x 1.6  
<sup>2</sup>H. H. Beverage, C. W. Rice and E. W. Kellogg, "The Wave Antenna, a New Type of Highly Directive Array." *Trans. A.I.E.E.*, vol. 42, Feb. 1923.  
<sup>3</sup>I. Herlitz, "Analysis of Action of Wave Antennas." *Trans. A.I.E.E.*, 1923, vol. 42, pp. 260-266.  
<sup>4</sup>H. H. Beverage, "A Wave Antenna for 200 Meter Reception." *QST*, Nov. 1922, p. 7 (see update of 1922 article in *QST*, Jan. 1982, p. 11).  
<sup>5</sup>J. R. Wait, and J. E. T. Mousseau, "Calculated Field Patterns for Horizontal Travelling Wave

Antennas." Radio Physics Laboratory, Project Report No. 19-0-2, Jan. 15, 1953.  
<sup>6</sup>D. N. Travers, P. E. Martin and W. W. Sherrill, "Use of Beverage Antenna in Wide Aperture High Frequency Direction Finding (Pt. IV Theory)." Interim Report for Contract NObsr-89345, Southwest Research Institute, March 23, 1964.  
<sup>7</sup>P. E. Martin, D. N. Travers and R. Lorenz, "Circular Arrays of Beverage Antennas for High Frequency Direction Finding." paper submitted for technical program, Southwestern IEEE, April 1965.  
<sup>8</sup>J. Litva and B. J. Rook, "Beverage Antennas for HF Communications. Direction Finding and Over-

the-Horizon Radars." Communications Research Centre Report No. 1282, Ottawa, Aug. 1976.  
<sup>9</sup>E. A. Laport, *Radio Antenna Engineering* (New York: McGraw Hill Book Co., Inc. 1952), pp. 55-60.  
<sup>10</sup>V. A. Mizek, *The Beverage Antenna Book* (Hudson, NH: V. A. Mizek, 1977).  
<sup>11</sup>C. Barnes, "XELEDOP Antenna Pattern Measuring Equipment, 2 to 50 MHz," Stanford Research Institute, Menlo Park, CA, July 1965.  
<sup>12</sup>G. E. Moss, N. Muirhead and R. W. Jenkins, "The Use of Multiple-Element Beverage Antenna Arrays for HF Transmission." Communications Research Centre Report No. 1318, July 1978. □

# New Products

## MOTOROLA BIPOLAR PROM

Motorola has introduced a 16-K Schottky TTL PROM, the MCM76161, with a 70 ns (maximum) address-access time. This fully decoded, high-speed, field-programmable ROM is organized as 2K, 8-bit words and is pin compatible with standard PROMs and ROMs. Three-state outputs and chip-enable inputs allow expansion to larger arrays.

The PROM is manufactured with a logical 1 (output high) at each location, and can be programmed selectively for logical 0 (output low) by raising the 5-V supply to 12-V with a rise time greater than 1 μs. The programming delay is typically 100 μs.

In a family of PROMs ranging in density from 2K to 16K, the MCM76161 is the highest-complexity product. Typical access times are 45 ns and 30 ns for address and chip-enable. The TTL-compatible outputs can sink 16 mA and source 2 mA. Supply current is typically 130 mA. In quantities of 100 to 999, the price is \$18.85 each. For further information contact Jim Miele at Motorola Semiconductor Products Inc., P.O. Box 20912, Phoenix, AZ 85036. — *Paul K. Pagel, N1FB*

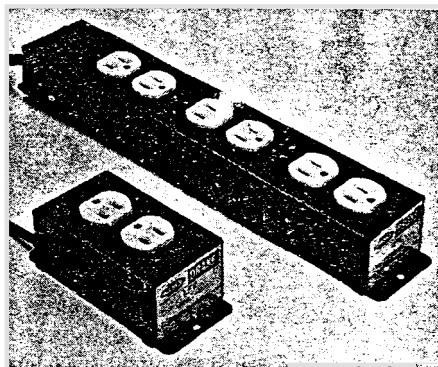

MOV used is rated to handle voltage spikes having an 8 μs rise time and duration of 20 μs with a maximum spike current of 100 A. The rf line filters consist of ferrite-core inductors and disc-ceramic capacitors arranged in a T configuration on each side of the ac line.

Black-anodized aluminum enclosures are used for the filter assemblies. A no. 10 bolt is affixed to one end of the case. This grounding stud should be connected to a nearby station ground point. It is internally connected to the case, the duplex outlet ground and the ground wire of the ac line cord.

A lighted ON/OFF rocker switch on the LF6 indicates when power is supplied to the outlets. This filter is also supplied with a 15-A line fuse; the LF2 is unfused. A three-conductor ac line cord attaches each filter assembly to the ac source.

The LF2 measures 5.4 x 2.4 x 1.7 inches (LWD) and the LF6 is 16.2 x 2.4 x 1.7 inches (LWD) in size. Price class of the LF2 is \$40 and \$70 for the LF6. They are available from the R. L. Drake Company, 540 Richard St., Miamisburg, OH 45342. — *Paul K. Pagel, N1FB*

<sup>1</sup>mm = inches x 25.4

## MOTOROLA SINGLE-ENDED SWITCHMODE® CONTROL CIRCUITS

□ A series of single-ended Switchmode® pulse-width modulation control circuits, MC34060/MC35060, has been in-

troduced by Motorola. Designed specifically for Switchmode® power supply control, the MC34060/MC35060 is a low-cost, single-ended version of the Texas Instruments TL494 push-pull control circuit. Its electrical specifications are identical to the TL494 for all common characteristics.

These devices feature complete pulse width modulation control circuitry, adjustable dead-time control, and an uncommitted output transistor which can source or sink 200 mA. The MC34060/35060 has on-chip error amplifiers, a 5-V reference and an oscillator with master or slave operation. They're available in 14-pin plastic and ceramic packages with an operating temperature range of 0 to +70° C. The plastic MC34060 and ceramic MC34060 are \$1.85 and \$2.15 each, respectively, in quantities of 100 to 999. A full-temperature-range (-55 to +125° C) version is available in the ceramic package only (MC34060L) at \$7.85 each in 100 to 999 quantities. For further information, contact Bob Benzer at Motorola Semiconductor Products Inc., P.O. Box 20912, Phoenix, AZ 85036. — *Paul K. Pagel, N1FB* □

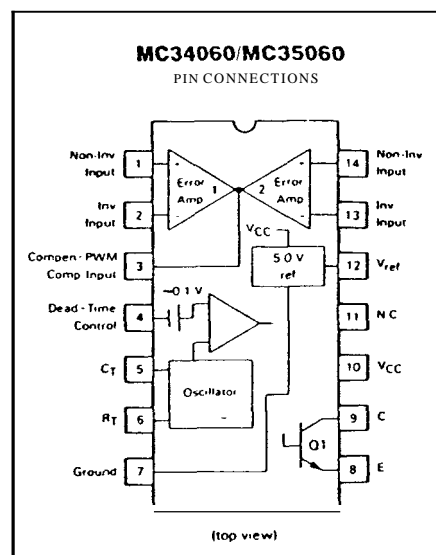

tion, which is converted internally to four characters, in accordance with CCIR Recommendation 491. Nevertheless, amateur and commercial stations may communicate easily with one another once the appropriate selcode is determined.

#### Is the AMTOR Block Design Appropriate?

Recognizing that AMTOR achieves nearly perfect elimination of transmission error, one may ask what can be done to improve transmission speed. CCIR 476 yields a communications efficiency of 50%, in the sense that a 100-baud radio channel (with ARQ handshaking) produces a 50-baud teleprinter output. To increase the AMTOR data rate one may adjust either the signaling speed or the ARQ efficiency.

The question of efficiency recalls a most striking feature of AMTOR — the relatively few characters (three per block) transmitted at a time. One may ask if increasing the block length will substantially reduce handshaking overhead. In my opinion, the block length cannot be increased usefully beyond a factor of 5 or 10. The problem is that with marginal hf circuits the probability of a "hit" in an interval of several seconds is very high. Using a block length of 80 characters (one line of text) seems foolhardy if communication is to be attempted during poor conditions. Perhaps an adaptive system that matches block length to channel statistics, or a method of correcting individual errors within a long block, would yield useful improvement in ARQ efficiency.

#### 7.0 PREDICTIONS FOR AMTOR USE

AMTOR performance is such a significant improvement over conventional RTTY that enthusiasts are given to forecasting its exclusive use within a few short years. Comparison with the history of ssb telephony is unavoidable. Yet AMTOR, as is, suffers from the 50-baud limitation on transmission rate. This is adequate for any link involving a typist, but how soon will the amateur's need for computer-to-computer communication grow beyond this modest speed? Stations may already be heard lamenting that more than 40 minutes is required to send an 8-K program over the air.

Thus, the future of AMTOR involves an estimate of amateur data transmission needs and our progress with the proposed wideband vhf data networks. If the need does not materialize quickly, or if the networks still require years of development, AMTOR may well establish itself as the dominant mode of amateur data communications.

Another factor affecting my prediction of exclusive AMTOR use on hf is my preoccupation with long-haul circuits that are reliable 24 hours per day. These considerations are not typical of the great bulk of amateur RTTY communication. 100 wpm (or, possibly, 300 wpm) Baudot and ASCII codes work well on continental U.S. Paths during good band conditions. Nevertheless, I find that, when a station has the option, AMTOR is invariably selected. It extends our communication range, increases the time "window" during which a circuit is open, and provides that wonderful certainty of perfect print on the other end. — William C. Meyn, K4PA, Reston, Virginia

#### AID FOR PROGRAMMERS

First, congratulations on publishing the fine article by Rose, K6GKU, on the MINIMUF Program (Dec. 1982 QST). I was, however, somewhat disappointed when I read the editor's note on page 38. There is, and has been for some

time, a book addressing the problem of using a program on a computer for which it has not been written. The book is David Lien's (W6OVP) *BASIC Handbook*, available from CompuSoft Publishing, 535 Broadway, El Cajon, CA 92021, for \$19.95 + \$1.65 postage and handling.

With the *BASIC Handbook*, anyone can translate the many different BASIC language "dialects" to their own computer syntax. The book is really a "must have" for any serious microcomputer owner. — Leslie S. Smith, KAMXX, San Diego, California

#### LINE LOSS AND SWR

While it is true that moderately high SWRs on transmission lines of average length at the lower frequency bands are of minor importance, things can get out of hand. When the 10-MHz band legally opened, my friend W7IR was anxious to give it a try, since his new rig includes that band. He has an inverted V cut for 3.6 MHz, and reasoned that since the third harmonic of that band is not too far from 10 MHz, it might work on the new band. The SWR at 10 MHz was about 5:1; this was overcome easily with a matching network. Signal reports were disappointing, however, even allowing for the 100-W output of the transceiver.

He then realized that his transmission line (mil-spec RG-8A/U) is 350 feet long, and perhaps the attenuation was causing the SWR to look much better than it really was. (At 10 MHz, RG-8A/U has an attenuation of 0.55 dB per 100 feet, or about 2.0 dB for the whole line.)

This attenuation figure means that, even if there is no antenna connected to the end of the line, the return loss measured at the shack end can be no greater than 4.0 dB; the SWR can never look higher than 4.4:1!

Actually, the antenna (there really was an antenna at the end of the line!) was radiating a small amount of power, but W7IR had not intended to operate QRP! W7IR is now looking for a place to hang a 10-MHz antenna, preferably closer to the shack. — Harry R. Hyder, W7IV, Tempe, Arizona

## Feedback

W2HXF correctly points out that the pictorial drawing of T1 in Fig. 4 of "Go Class B or C with Power MOSFETs," March 1983 QST, p. 27, has an error. Leads D and E should be joined, rather than leads C and D. The schematic diagram for T1 is correct, however. Also, T2 should have been described as a bifilar choke.

There is a typographical error in "More MINIMUF Program Mods" (Technical Correspondence, May 1983). The following line should read:

2010 B1 = (remainder per May issue)

Author Bramwell is credited with the correction.

VE2CV has pointed out that in Fig. 7 of "The Effect of Supporting Structures on Simple Wire Antennas," Dec. 1982 QST, p. 34, the angles in the small insert have been reversed. The angle  $\theta$  is the angle of elevation for launch of skywaves;  $\phi$  is the azimuthal angle ( $\phi = 90^\circ$  is the plane orthogonal to the plane containing the antenna).

In "SOLAR FLUX/SUNSPOT NUMBER CONVERSION FOR MINIMUF" (Technical

Correspondence, May 1983), there are errors in Eq. 3. It should read  $S9 = 625 * (SQR((0.73) * 2.0.0032 * (65-SF)) - 0.73)$  (Eq. 3)

Thanks to K4JW for picking this up.

Author Belrose points out that there are several errors in the Appendix of his January 1983 QST article entitled, "Beverage Antennas for Amateur Communications." Eq. 1 should read:  $Z_0$  equals 60 times the natural logarithm of  $2h/a$ . While the symbol  $n$  is defined correctly, this definition should have appeared in the text after the list of definitions following Eq. 6. Eq. 5 should read

$$G = \frac{377 \pi \sin^2 \delta}{Z_0 \lambda^2} \left| \frac{1 - e^{-\Gamma}}{\Gamma} \right|^2 \quad (\text{Eq. 5})$$

Eq. 4 was converted incorrectly from metric to English units. It should have read

$$Z_0 = 60 \ln \frac{2(3.7)(12)}{0.0404} = 462 \text{ ohms (Eq. 4)}$$

where

$h = 3.7$  feet (1.13 m)

$a = 0.0404$  inches (0.1026 cm)

QST has received a virtual landslide of information from various sources telling us that the June Stray entitled "Contact-Lens Wearers Beware!" (page 22) is erroneous. Apparently, we (along with several other publications) were the victims of a hoax: The incident described in the Stray, according to the information we've received since the Stray appeared in print, did not occur. The underlying message is this, according to the National Society to Prevent Blindness: "Contact lenses, of themselves, do not provide eye protection in the industrial sense. For occupational use, contact lenses should be worn only in conjunction with appropriate industrial eye protection."

## Strays



The League's 1979 GMC pickup truck, used mainly for hauling mail to and from the Post Office, is sporting a new license plate, compliments of the family of the late Francis E. Handy, W1BDI. The family graciously transferred ownership of the license plate to the League in memory of Handy's 42 years of service to the ARRL and Amateur Radio. Known affectionately as "Mr. Amateur Radio," Handy is best known for creating *The Radio Amateur's Handbook* ("Handy's Handy Handbook") and for founding the ARRL section-level organization and Field Day, which, by the way, celebrates its 50th anniversary this year.